

ROWENTA

PERFECT

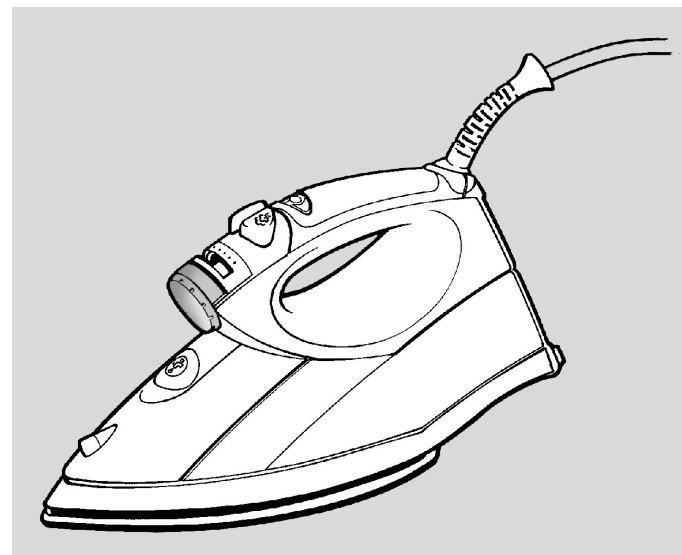

- | | | |
|----|--|---------------------|
| GB | Please read carefully the instructions for use and the Safety Points to Note. Pay particular attention to the fold-out page with the illustrations. | page
1 |
| D | Bitte lesen Sie diese Gebrauchsanweisung und die Sicherheitshinweise aufmerksam durch. Beachten Sie dabei die Abbildungen auf der ausklappbaren Bildseite. | Seite
6 |
| F | Lire attentivement le mode d'emploi (et le conserver pour pouvoir le consulter). Pendant la lecture, déplier la page avec les illustrations. | page
11 |
| I | Leggere attentamente le presenti istruzioni per l'uso e le norme di sicurezza. Osservare la figura sui risvolli illustrati. | pagina
16 |
| E | Lea en su totalidad el modo de empleo, conservándolo para consultas posteriores. Para su lectura, abra por la página ilustrada. | pág.
21 |
| P | E favor ler com toda a atenção estas instruções de serviço, assim como as instruções de segurança. Sera conveniente consultarem se as figuras que se encontram nas página ilustrada desdobreveil. | pag.
26 |
| RF | Пожалуйста, тщательно прочитайте эту инструкцию по эксплуатации и обратите особое внимание на правила техники безопасности. Во время чтения этой инструкции обратит внимание на рисунок, изображенный на внутренней стороне сложной брошюры. | стр.
31 |

PERFECT

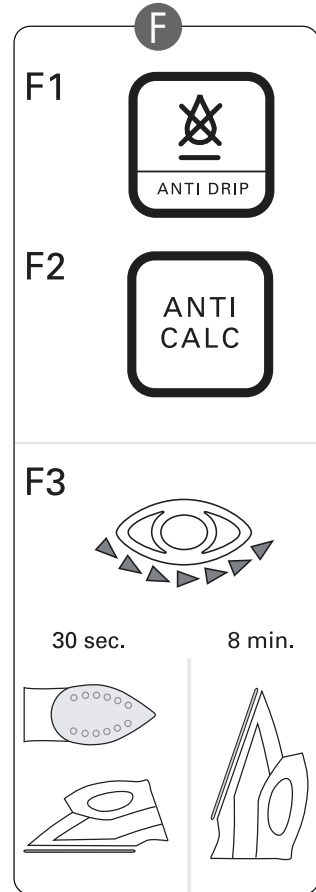
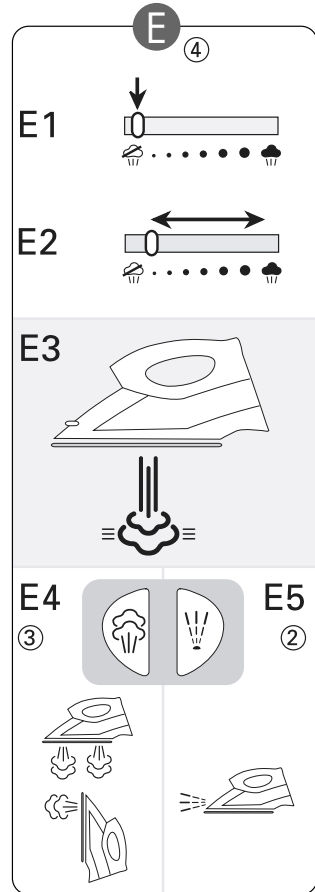
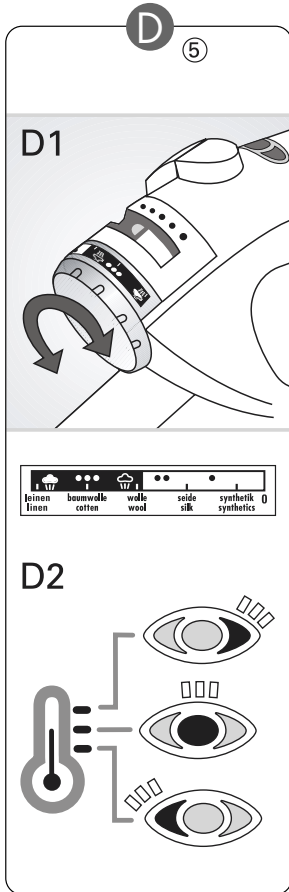
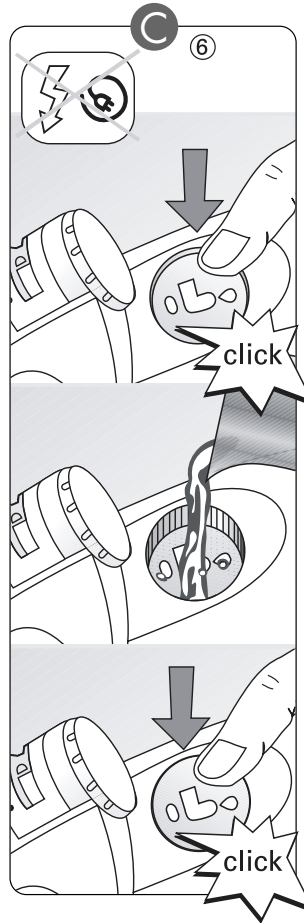
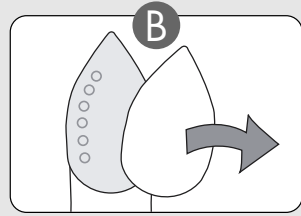
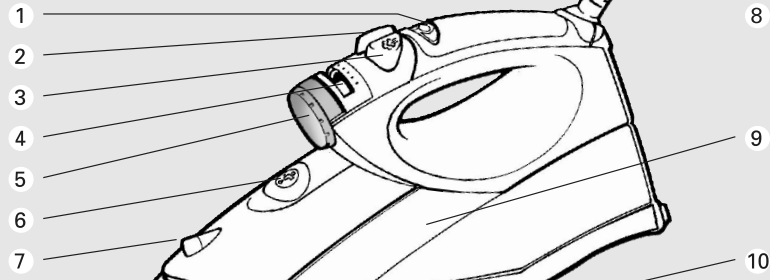

English

Dear customer,
thank you for purchasing this appliance and for your confidence in us. Please read the operating instructions carefully and keep them in a safe place.

A

Appliance description

- | | |
|-------------------------------|---|
| 1 LED „Traffic Light“ display | 6 Filling inlet (with push-button opening) |
| 2 Spray button | 7 Spray nozzle |
| 3 Power steam button | 8 Mains supply cord |
| 4 Variable steam control | 9 Water tank with maximum water level indicator |
| 5 Temperature control dial | 10 Soleplate (depending on model) |

Safety instructions

- The appliance complies with EU directives 72/23/EEC and 89/336/EEC.
- The appliance may only be connected to alternating current as specified on the rating plate.
- If the detachable fuse cover is lost, a replacement may be purchased from a Rowenta Service Centre (see enclosed Service Information leaflet).
- Information for supply may also be obtained from the plug manufacturer.
- An electrical appliance is not a toy. Use and store the appliance out of reach of children. Do not let the supply cord hang down.
- Do not leave the appliance unattended while it is connected to the mains supply.
- Electrical appliances generate high temperatures. Always use the handles provided and warn other users of the potential dangers (e.g. escaping steam or hot water, especially when ironing vertically).
- Never treat clothing which is being worn.
- Always disconnect the appliance:
 - before filling or emptying the water tank;
 - before leaving the room (even for a short time);
 - after use.
- Never unplug the appliance by tugging on the cord.
- Only safe extension leads should be used.
- Do not immerse the appliance in water.
- An electrical appliance should not be used if:
 - the appliance, the supply cord or the cord protector is damaged;
 - the appliance has been dropped;
 - the appliance is obviously leaking. In this case the appliance should be returned to an approved Rowenta Service Dealer for repair. (See enclosed list for addresses.)
- Repairs to electrical appliances may only be carried out by specialists. Improperly carried out repairs can cause serious danger to users. To avoid danger to users, a defective or damaged supply cord may only be replaced by an authorised Rowenta service centre.
- Rowenta accepts no liability for damage arising from improper use or operation (see also POINTS TO NOTE). This appliance is for domestic use only.
- When the appliance has reached the end of its operational life it should be disposed of through the correct channels.



B Before use



Before doing anything else, remove the soleplate protector!

Before ironing for the first time heat the appliance at the maximum setting (see D "Setting the temperature"). A little smoke and a slight smell may be emitted, but this is only temporary. The water tank can then be filled directly (see C "Filling with water/topping up"). Before ironing for the first time and after filling and heating up, the iron should be allowed to emit steam for at least 1 minute to remove any impurities.

C Filling / topping up water



Before filling the water tank, pull out the mains plug and set the steam control to position ☞.

Tilt the iron. The filler inlet can easily be opened by pressing the push-button. The inlet will open with a "click". Pour in water up to the max (9) mark. Close the filler inlet by pressing the push-button again, before returning the iron to the horizontal.

What water may be used ?

Your iron has been designed to operate using tap water. However, if your water is very hard, you can mix it 50% tap water with 50% distilled or demineralised water.



Do not add anything to the contents of the water tank and do not use water from clothes dryers, scented or softened water, water from refrigerators, batteries or air conditioners, pure distilled water or rain water. These contain organic waste or mineral elements that become concentrated when heated and cause spitting, brown staining or premature water to your iron.

D Setting the temperature

D1 Electronic temperature control (Thermo Control)

On your electronic iron you can set the precise ideal temperature for each material. The different types of material are shown on the temperature control dial:

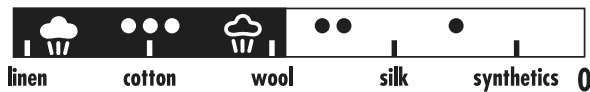

The soleplate of your iron is fitted with an electronic sensor which continuously monitors the temperature of the soleplate and keeps it at the precise selected setting. This enables you always to iron at the optimum temperature.

D2 LED "TRAFFIC LIGHT" DISPLAY

The traffic lights tells you whether the soleplate is at the selected temperature (see table below).

Colour	LED display	This means:	What to do
YELLOW		The soleplate is still too cold for the selected material.	You can start ironing now, but the soleplate is not yet at the selected temperature.
GREEN		The soleplate is at the right temperature for the selected material.	You can start ironing now. The soleplate is at the optimum temperature for your material.
RED		The soleplate is still too hot for the selected material.	Wait for the iron to cool down to the selected temperature and the LED display to switch to GREEN.

Tip: We recommend that you start with fabrics to be ironed at a low temperature as the iron takes longer to cool down than to heat up. For mixed fabrics set the temperature for the most delicate fabric.

E Ironing and Steam functions

E1 Dry ironing

To iron without continuous steam, turn the steam control to ☞ and set the temperature to suit the type of material (care points •, **, ***).

E2 Steam ironing

You can steam iron from temperature setting ** up. The steam quantity can be set to between ☞ (minimum steam quantity) and ☞ (maximum steam). We recommend setting to maximum steam quantity only when the iron is at temperature setting ***.

E3 Intra Steam

Your iron is fitted with the new Intra Steam system. This technology generates higher steam pressure to enable the steam to penetrate much faster and further into the fabric. This way you get excellent results from your ironing. The steam is emitted in frequent bursts rather than continuously. The pressure generated may cause a slight noise. **This is not a technical fault!**

E4 Power steam button (from temperature setting ** up)
To generate a powerful jet of steam and remove stubborn creases, press the power steam button.

Vertical steam ironing (from temperature setting ** up)
Ideal for removing creases from suits, jackets, skirts, hanging curtains etc.

Important:

Never steam or iron clothing that is being worn!

- Hang up the garment on a hanger and hold the fabric slightly taut with one hand.
- Set the thermostat control to maximum steam
- Hold the iron a few centimetres away from the garment to avoid burning delicate fabrics.
- Press the power steam button repeatedly, moving the iron from top to bottom.

The power steam and vertical steam functions (E 4) are also possible if the steam control is set to . The interval between bursts of steam should be about two seconds.



Important:
Never direct the steam at persons or animals!

- E5 Spray function
To dampen stubborn creases, press the spray button.

F Additional functions

- F1 Anti-Drip system
Prevents water escaping from the soleplate when the temperature is too low.
- F2 Anti-scale system
Your iron contains an anti-scale cartridge to reduce scale deposits. This considerably prolongs the operational life of your iron. The anti-scale cartridge is an integral part of the water tank and need not be replaced.



Do not use descaling agents, as these damage the lining of the steam chamber and so may impair the steam function.

- F3 Automatic electronic 3-position cut-out (depending on model)
If, although switched on, the appliance is not moved, it will automatically switch off after the following intervals:

After 30 sec., if the iron is standing on the soleplate or lying on its side.

After 8 mins., if the iron is standing on its heel.

The LED display starts to flash yellow-green-red in regular sequence. If the appliance is moved, it will automatically switch on again and begin to heat up again.

G After ironing

- Unplug from the mains, pour away remaining water and set steam control to . Then allow the appliance to cool down.
- Store the iron standing on its heel.
- Do not wind the cord round the hot soleplate.

H Cleaning and maintenance

When the appliance has cooled down, wipe it down with a damp cloth or sponge, as required.

Dirt can be removed from the soleplate with a damp cloth or sponge. **Do not use sharp or abrasive cleaning agents or objects.**



Important: If the appliance has been standing unused for long periods, hold it horizontal and allow it to emit steam for approx. 1 minute to clean the steam ducts and remove any residue from the iron.

I Problems?

Problems	Possible cause	Solution
The iron is plugged in, but the soleplate of the iron remains cold.	No mains supply.	Check that the mains plug is properly inserted or try plugging the iron into a different socket.
The soleplate is not heating up properly.	The temperature control is set too low.	Set the temperature control to a higher temperature (D).
LED „Traffic Light“ display does not light up.	Temperature control set to "0".	Turn the temperature control to the required setting.
None or too little steam is being emitted.	There is insufficient water in the water tank.	Fill the water tank (C).
	Anti-Drip is active (F1).	Wait for the soleplate to reach the correct temperature.
All 3 colours of the Traffic Light display flash alternately.	The automatic cut-out has activated: the appliance is on standby.	If moved, the appliance will switch on again.
The traffic Light display flashes red fast.	The temperature sensor in the soleplate is defective.	Call our Customer Relations Helpline – see below
Brown streaks come through the holes in the soleplate and stain the fabric.	You are using chemical descaling agents.	Do not add any descaling agents to the water in the water tank.
	You linen is not rinsed sufficiently or you have ironed a new garment before washing it.	Ensure linen is rinsed thoroughly to remove any soap deposits or chemicals on new garments which may be sucked up by the iron.
The soleplate is dirty or brown and can stain the linen.	You are using a too high temperature.	See the temperature table to correctly set the thermostat.
	You are using starch.	Clean the soleplate as indicated above. Always spray starch onto the reverse side of the fabric to be ironed.
The soleplate is scratched or damaged.	You have placed your iron flat on a metallic rest-plate.	Always set the iron on its heel.
	You have ironed over a zip.	Try to avoid ironing over zips which may have rough edges.

If you have any further problems or queries with our products please call our Customer Relations team first for expert help and advice:

HELPLINE:0845 602 1454 – UK, 01 4751947 – Ireland

If you are unable to trace the cause of the fault, contact an official Rowenta Customer Service Centre. The addresses are shown in the enclosed service centre address list. Further hints and tips are obtainable from our homepage: www.rowenta.com.

In line with a policy of continuous product improvement Rowenta reserves the right to change product specifications without prior notice.